

KNIFE

Pleat Bespoke Fabric Empire Shade 30cm

Our Knife Pleat shades are carefully folded and stitched by hand. They are then lined with a pleated taffeta lining and finished with a handmade self-trim.

Bulb not included; takes 1 x 60W max ES GLS. We recommend our BUL-E27-LED-17 bulb. [Click here to shop.](#)

Bespoke Shades

Our high quality fabric shades, hand crafted in our Oxfordshire workshop by our sister brand The Light Shade Studio, with a choice of luxurious fabrics in 100% Dupion Silk, Satin or Linen in an array of shapes, sizes, and colours. If you would like to supply your own fabric, then please contact us to discuss your personalised requirements. Customise your shade by using our product configurator to see your design before placing an order.

Returns

As our bespoke or customised fittings are made to your specific specification, these are not covered by our standard returns policy. We are unable to offer refunds after the initial 24 hour cooling off period. Please see our Terms and Conditions for more details. None of the above affects your statutory rights where goods are faulty or not as described.



SPECIFICATIONS:

Product code:	PLK30
Measurements:	H21 x Ø30cm
Finish:	Bespoke
Material:	Fabric
Shade Included:	Shade Only
Primary Bulb Detail:	1 x 60w max ES GLS
Bulb Included:	Lamp not included
Recommended Lamp:	BUL-E27-LED-17
Suitable:	Indoor
Nett Weight (kg):	0.4 kg

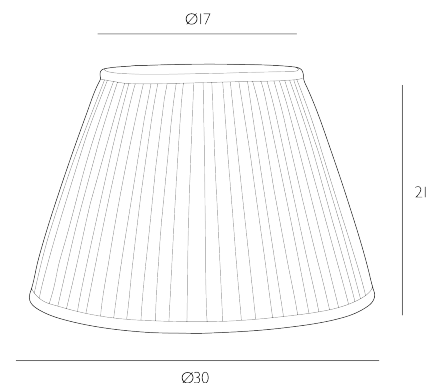

Additional Information:

Lamp not included. We recommend our BUL-E27-LED-17 bulb | Supplied with Bespoke Fabric shade

