

EMPIRE

Drum Bespoke Fabric Empire Shade 35cm

A timeless Empire Tapered drum shade with a sharp rolled edge finish.

Comes with a reducer ring so it is suitable for both E27 and E14 fittings.

To enhance the look, why not check out our Shade Accessories.

Suspensions: [Click here to shop.](#)

Bulb not included; takes 1 x 60W max to fit E27 (non elec) + Reducer
GLS. We recommend our BUL-E27-LED-16 bulb. [Click here to shop.](#)



Bespoke Shades

Our high quality fabric shades, hand crafted in our Oxfordshire workshop by our sister brand The Light Shade Studio, with a choice of luxurious fabrics in 100% Dupion Silk, Satin or Linen in an array of shapes, sizes, and colours. If you would like to supply your own fabric, then please contact us to discuss your personalised requirements. Customise your shade by using our product configurator to see your design before placing an order.

Returns

As our bespoke or customised fittings are made to your specific specification, these are not covered by our standard returns policy. We are unable to offer refunds after the initial 24 hour cooling off period. Please see our [Terms and Conditions](#) for more details. None of the above affects your statutory rights where goods are faulty or not as described.

SPECIFICATIONS:

Product code:	EMP35
Measurements:	H22 x Ø35cm
Lamp Replaceable:	Yes
Finish:	Bespoke
Material:	Fabric
Shade Included:	Shade Only
Primary Bulb Detail:	1 x 60w max E27 (with E14 Reducer)
Bulb Included:	Lamp not included
Recommended Lamp:	BUL-E27-LED-16
Suitable:	Indoor
Nett Weight (kg):	0.5 kg

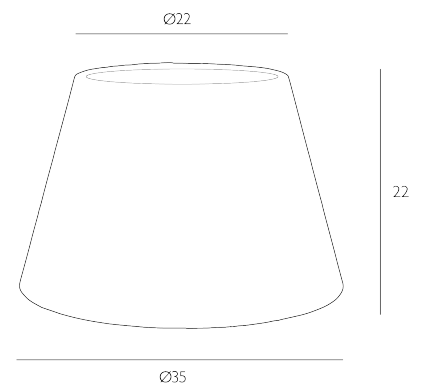

Additional Information:

Lamp not included. We recommend our BUL-E27-LED-16 bulb | Supplied with Bespoke Fabric shade

www.davidhuntlighting.co.uk

| sales@davidhuntlighting.co.uk

| 01295 672 628